

All inclusive stand packages - with one signature to the fair

Trade Fairs Brno
Výstaviště 405/1
603 00 Brno
Tel.: +420 541 152 912
E-mail: mmiksa@bv.v.cz
www.bv.v.cz/expozice



May 28 - 30, 2025, Brno - Czech Republic, www.idet.cz



Special discount for registration till December 10, 2024

B1
9 m²

Standard stand - TYPE B1, 3 x 3 m, total price up to 10. 12. 2024 CZK 90 400,- excl. VAT after 10. 12. 2024 CZK 98 500,- excl. VAT

The price includes: 9 m2 exhibition area, registration fee, stand construction incl. furnishings (see the list), carpet flooring, an inscription of up to 15 characters on fascia, power supply up to 3,6 kW incl. testing, daily cleaning, the company name and address in the fair catalogue and in the electronic information system, 2x Assembly/Dismantling Pass, 2x Exhibitor's Pass.

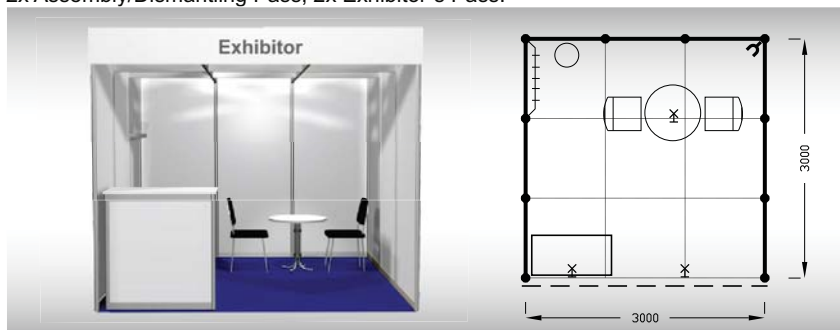

Stand furnishings:

- 1x 70 cm round table
- 2x chair Bystřice
- 1x information desk
- 1x coat rail
- 1x wastebasket
- 3x spotlights
- 1x 220 V socket

B2
12 m²

Standard stand - TYPE B2, 4 x 3 m, total price up to 10. 12. 2024 CZK 117 200,- excl. VAT after 10. 12. 2024 CZK 127 900,- excl. VAT

The price includes: 12 m2 exhibition area, registration fee, stand construction incl. furnishings (see the list), carpet flooring, an inscription of up to 15 characters on fascia, power supply up to 3,6 kW incl. testing, daily cleaning, the company name and address in the fair catalogue and in the electronic information system, 2x Assembly/Dismantling Pass, 2x Exhibitor's Pass.

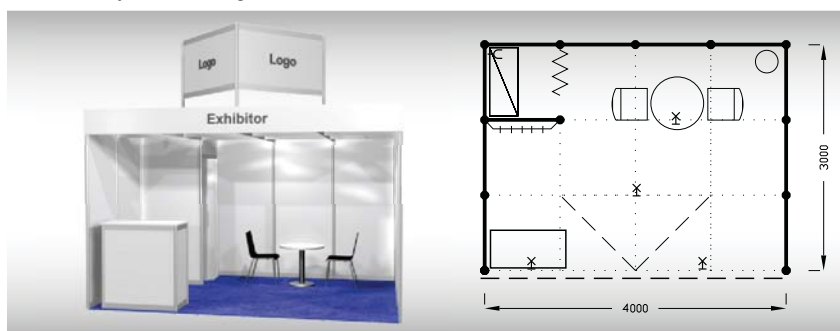

Stand furnishings:

- 1x 70 cm round table
- 2x chair Bystřice
- 1x information desk
- 1x coat rail
- 1x shelf
- 1x wastebasket PVC
- 4x spotlight
- 1x 220 V socket
- 2x graphic surface 136 x 67 cm excl. graphic

B2R
12 m²

Standard stand - TYPE B2R, 4 x 3 m, total price up to 10. 12. 2024 CZK 119 900,- excl. VAT after 10. 12. 2024 CZK 131 100,- excl. VAT

The price includes: 12 m2 exhibition area, registration fee, stand construction incl. furnishings (see the list), carpet flooring, an inscription of up to 30 characters on fascia, power supply up to 3,6 kW incl. testing, daily cleaning, the company name and address in the fair catalogue and in the electronic information system, 2x Assembly/Dismantling Pass, 2x Exhibitor's Pass.

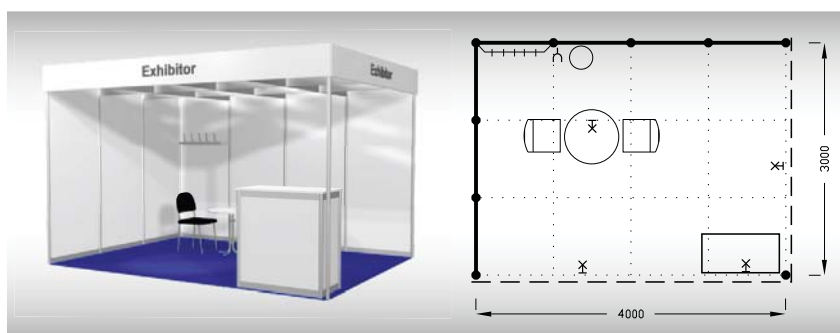

Stand furnishings:

- 1x round table 70 cm
- 2x chair Bystřice
- 1x information desk
- 1x coat hanger
- 1x wastebasket
- 4x spotlights
- 1x 220 V socket

Common conditions for all types and sizes of stands:

- The stand will be ready at 10.00 a.m. one day before the fair begins
- Note! - stand dismantling will begin the following day after the fair has ended
- Structural changes for all types of packages are not possible
- Should the exhibitor attach their own posters /banners/ stickers to the wall panels inconsiderately resulting in panel damage, they will be charged an extra fee CZK 880,- / 1 piece
- Rejection or exchange of basic furnishings will not be compensated by any price reduction
- Changes in type and proportion of exhibition area for all types of package stands are not possible
- Stand cleaning is performed every morning before the fair begins

All inclusive stand packages - with one signature to the fair

Trade Fairs Brno
Výstaviště 405/1
603 00 Brno
Tel.: +420 541 152 912
E-mail: mmiksa@bv.v.cz
www.bvv.cz/expozice



May 28 - 30, 2025, Brno - Czech Republic, www.idet.cz



Special discount for registration till December 10, 2024

B3
15 m²

Standard stand - TYPE B3, 5 x 3 m, total price up to 10. 12. 2024 CZK 139 800,- excl. VAT after 10. 12. 2024 CZK 152 900,- excl. VAT

The price includes: 15 m2 exhibition area, registration fee, stand construction incl. furnishings (see the list), carpet flooring, an inscription of up to 15 characters on fascia, power supply up to 3,6 kW incl. testing, daily cleaning, the company name and address in the fair catalogue and in the electronic information system, 2x Assembly/Dismantling Pass, 2x Exhibitor's Pass.

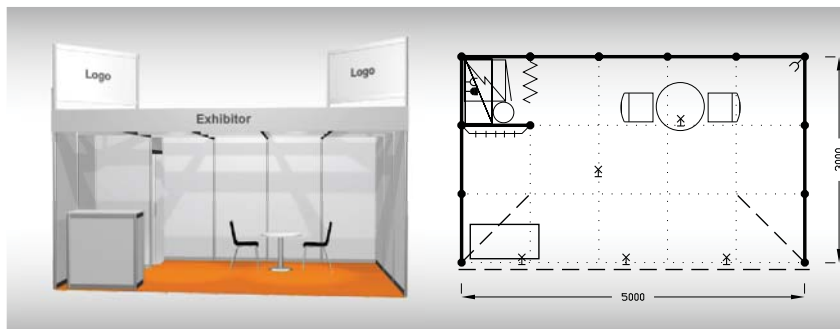

Stand furnishings:

- 1x 70 cm round table
- 3x chair Bystřice
- 1x information desk
- 1x refrigerator, 1x shelf
- 1x coat rail
- 1x wastebasket PVC
- 5x spotlight
- 2x 220 V socket
- 1x socket for refrigerator
- 2x graphic surface 136 x 67 cm excl. graphic

B3R
15 m²

Standard stand - TYPE B3R, 5 x 3 m, total price up to 10. 12. 2024 CZK 147 200,- excl. VAT after 10. 12. 2024 CZK 160 800,- excl. VAT

The price includes: 15 m2 exhibition area, registration fee, stand construction incl. furnishings (see the list), carpet flooring, an inscription of up to 15 characters on fascia, power supply up to 3,6 kW incl. testing, daily cleaning, the company name and address in the fair catalogue and in the electronic information system, 2x Assembly/Dismantling Pass, 2x Exhibitor's Pass.

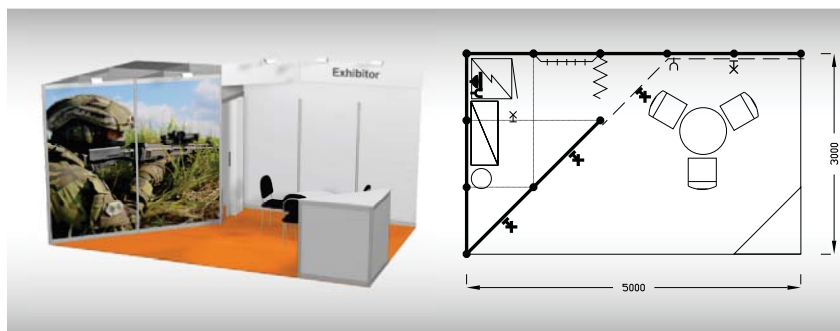

Stand furnishings:

- 1x 70 cm round table
- 3x chair Bystřice
- 1x information desk
- 1x refrigerator, 1x shelf
- 1x coat-rack
- 1x wastebasket
- 5x spotlights
- 2x 220 V socket
- 1x socket for refrigerator
- 1x graphic wall 276 x 234 m excl. graphic

B4R
20 m²

Standard stand - TYPE B4R, 5 x 4 m, total price up to 10. 12. 2024 CZK 206 000,- excl. VAT after 10. 12. 2024 CZK 226 500,- excl. VAT

The price includes: 20 m2 exhibition area, registration fee, stand construction incl. furnishings (see the list), carpet flooring, an inscription of up to 30 characters on fascia, power supply up to 6,9 kW incl. testing, daily cleaning, the company name and address in the fair catalogue and in the electronic information system, 2x Assembly/Dismantling Pass, 2x Exhibitor's Pass, input and waste of water.

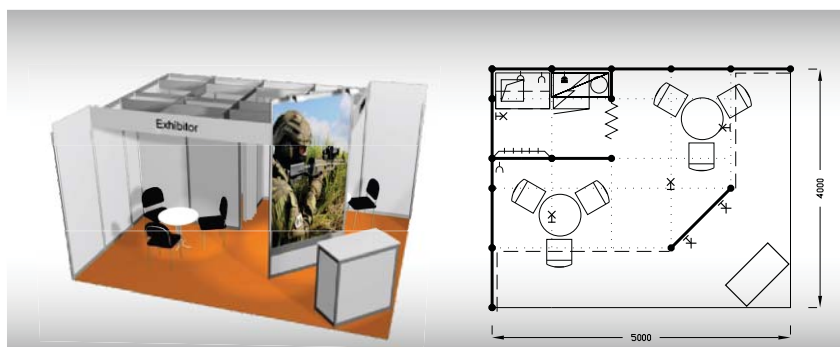

Stand furnishings:

- 2x 70 cm round table
- 6x chair Bystřice
- 1x information desk
- 1x kitchenette Omnia
- 1x refrigerator, 1x shelf
- 1x wastebasket
- 1x coat hanger
- 4x spotlights
- 2x light „Lopata”
- 3x 220 V socket
- 1x socket for refrigerator
- 1x graphic wall 136 x 234 cm (graphic design on payment)

Common conditions for all types and sizes of stands:

- The stand will be ready at 10.00 a.m. one day before the fair begins
- Note! - stand dismantling will begin the following day after the fair has ended
- Structural changes for all types of packages are not possible
- Should the exhibitor attach their own posters /banners/ stickers to the wall panels inconsiderately resulting in panel damage, they will be charged an extra fee CZK 800,- / 1 piece
- Rejection or exchange of basic furnishings will not be compensated by any price reduction
- Changes in type and proportion of exhibition area for all types of package stands are not possible
- Stand cleaning is performed every morning before the fair begins

All inclusive stand packages - with one signature to the fair

Trade Fairs Brno
Výstaviště 405/1
603 00 Brno
Tel.: +420 541 152 912
E-mail: mmiksa@bvv.cz
www.bvv.cz/expozice



May 28 - 30, 2025, Brno - Czech Republic, www.idet.cz



BVV
Veletrhy
Brno

Special discount for
registration till
December 10, 2024

Ex1
20 m²

**Standard stand - TYPE Ex1, 5 x 4 m, total price up to 10. 12. 2024 CZK 199 100,- excl. VAT
after 10. 12. 2024 CZK 217 800,- excl. VAT**

The price includes: 20 m² exhibition area, registration fee, stand construction incl. furnishings (see the list), carpet flooring, an inscription of up to 15 characters on fascia, power supply up to 6,9 kW incl. testing, switchboard, daily cleaning, the company name and address in the fair catalogue and in the electronic information system, 2x Assembly/Dismantling Pass, 4x Exhibitor's Pass, 1x unspecified car entry, input and waste of water.

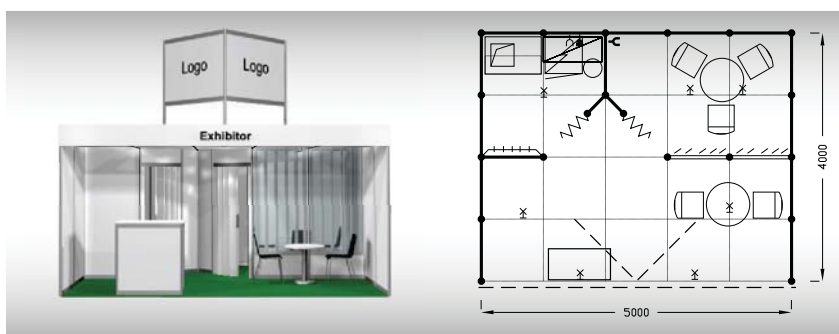

Stand furnishings:

- 2x 70 cm round table
- 5x chair Bystrice
- 1x information desk
- 1x kitchenette Omnia
- 1x refrigerator, 1x shelf
- 1x wastebasket
- 1x coat-rack
- 7x spotlights, 2x 220 V socket
- 1x socket for refrigerator
- 2x graphic surface 136 x 67 cm
excl. graphic

Ex1R
20 m²

**Standard stand - TYPE Ex1R, 5 x 4 m, total price up to 10. 12. 2024 CZK 205 900,- excl. VAT
after 10. 12. 2024 CZK 226 300,- excl. VAT**

The price includes: 20 m² exhibition area, registration fee, stand construction incl. furnishings (see the list), carpet flooring, an inscription of up to 30 characters on fascia, power supply up to 6,9 kW incl. testing, switchboard, daily cleaning, the company name and address in the fair catalogue and in the electronic information system, 2x Assembly/Dismantling Pass, 4x Exhibitor's Pass, 1x unspecified car entry, input and waste of water.

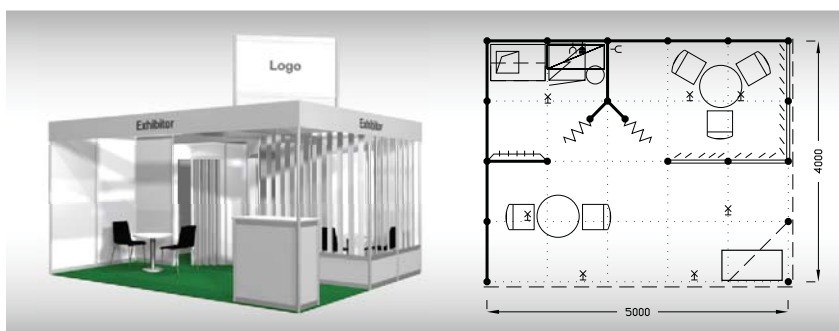

Stand furnishings:

- 2x 70 cm round table
- 5x chair Bystrice
- 1x information desk
- 1x kitchenette Omnia
- 1x refrigerator, 1x shelf
- 1x wastebasket
- 1x coat-rack
- 7x spotlights, 2x 220 V socket
- 1x socket for refrigerator
- 1x graphic surface 136 x 67 cm
excl. graphic

Common conditions for all types and sizes of stands:

- The stand will be ready at 10.00 a.m. one day before the fair begins
- Note! - stand dismantling will begin the following day after the fair has ended
- Structural changes for all types of packages are not possible
- Should the exhibitor attach their own posters /banners/ stickers to the wall panels inconsiderately resulting in panel damage, they will be charged an extra fee CZK 800,- / 1 piece
- Rejection or exchange of basic furnishings will not be compensated by any price reduction
- Changes in type and proportion of exhibition area for all types of package stands are not possible
- Stand cleaning is performed every morning before the fair begins

All inclusive stand packages - with one signature to the fair



Trade Fairs Brno
 Vystaviště 405/1
 603 00 Brno
 Tel.: +420 541 152 912
 E-mail: mmiksa@bvv.cz
 www.bvv.cz/expozice



May 28 - 30, 2025, Brno - Czech Republic, www.idet.cz

ADDITIONAL STAND EQUIPMENT

Exhibitor / Company name: _____

























Company address: _____ Place of business: _____

Contact person: _____

Phone: _____ Fax: _____ E-mail: _____

We make a firm order for additional equipment in addition to _____ package

(please indicate the type and size).

<p>Chair Bystrice I</p>  <p>Pcs <input type="text"/></p> <p>Price CZK 390,-</p>	<p>Round table 90 cm white</p>  <p>Pcs <input type="text"/></p> <p>Price CZK 790,-</p>	<p>Round table 70 cm white</p>  <p>Pcs <input type="text"/></p> <p>Price CZK 650,-</p>	<p>Bar stools „Z”</p>  <p>Pcs <input type="text"/></p> <p>Price CZK 1 000,-</p>	<p>Table buffet white</p>  <p>Pcs <input type="text"/></p> <p>Price CZK 1 300,-</p>
<p>Table 120 x 60 cm</p>  <p>Pcs <input type="text"/></p> <p>Price CZK 650,-</p>	<p>Table Classic 80 x 80 cm</p>  <p>Pcs <input type="text"/></p> <p>Price CZK 450,-</p>	<p>Lockable storage 1x1m2</p>  <p>Pcs <input type="text"/></p> <p>Price CZK 2 820,-</p>	<p>Information desk</p>  <p>Pcs <input type="text"/></p> <p>Height 110 cm Width 100 cm Depth 50 cm</p> <p>Price CZK 2 180,-</p>	<p>Shelf</p>  <p>Pcs <input type="text"/></p> <p>Price CZK 1 000,-</p>
<p>Eyecatcher front</p>  <p>Pcs <input type="text"/></p> <p>Price CZK 1 060,-</p>	<p>Eyecatcher arrow</p>  <p>Pcs <input type="text"/></p> <p>Price CZK 1 740,-</p>	<p>Lockable cabinet</p>  <p>Pcs <input type="text"/></p> <p>Height 68 cm Width 95 cm Depth 45 cm</p> <p>Price CZK 1 500,-</p>	<p>Table showcase</p>  <p>Pcs <input type="text"/></p> <p>Height 98 cm Width 95 cm Depth 45 cm</p> <p>Price CZK 2 600,-</p>	<p>Brochure stand</p>  <p>Pcs <input type="text"/></p> <p>Price CZK 1 200,-</p>
<p>Showcase with lighting</p>  <p>Pcs <input type="text"/></p> <p>Height 200 cm Width 50 cm Depth 50 cm</p> <p>Price CZK 2 900,-</p>	<p>Showcase 100 x 50 x 250 cm</p> <p>2x glass shelf</p>  <p>Pcs <input type="text"/></p> <p>Price CZK 3 860,-</p>	<p>Showcase 100 x 100 x 250 cm</p> <p>2x glass shelf</p>  <p>Pcs <input type="text"/></p> <p>Price CZK 4 480,-</p>	<p>Glass shelves 50 x 50 cm - for showcase</p>  <p>Pcs <input type="text"/></p> <p>Price CZK 280,-</p>	<p>Glass shelves 100 x 50 cm - for showcase</p>  <p>Pcs <input type="text"/></p> <p>Price CZK 370,-</p>
<p>Kitchenette Omnia</p>  <p>Pcs <input type="text"/></p> <p>excl. input and waste of water</p> <p>Price CZK 4 000,-</p>	<p>Refrigerator incl. socket</p>  <p>Pcs <input type="text"/></p> <p>Price CZK 3 490,-</p>	<p>Spotlight</p>  <p>Pcs <input type="text"/></p> <p>Price CZK 485,-</p>	<p>Spotlight with holder</p>  <p>Pcs <input type="text"/></p> <p>Price CZK 985,-</p>	<p>Socket 220 V</p>  <p>Pcs <input type="text"/></p> <p>excl. electricity</p> <p>Price CZK 325,-</p>

Other facilities can be ordered on a supplementary basis - see ieso.bvv.cz

Place, date

Name and surname of person authorised to sign on behalf of the exhibitor, stamp and signature