

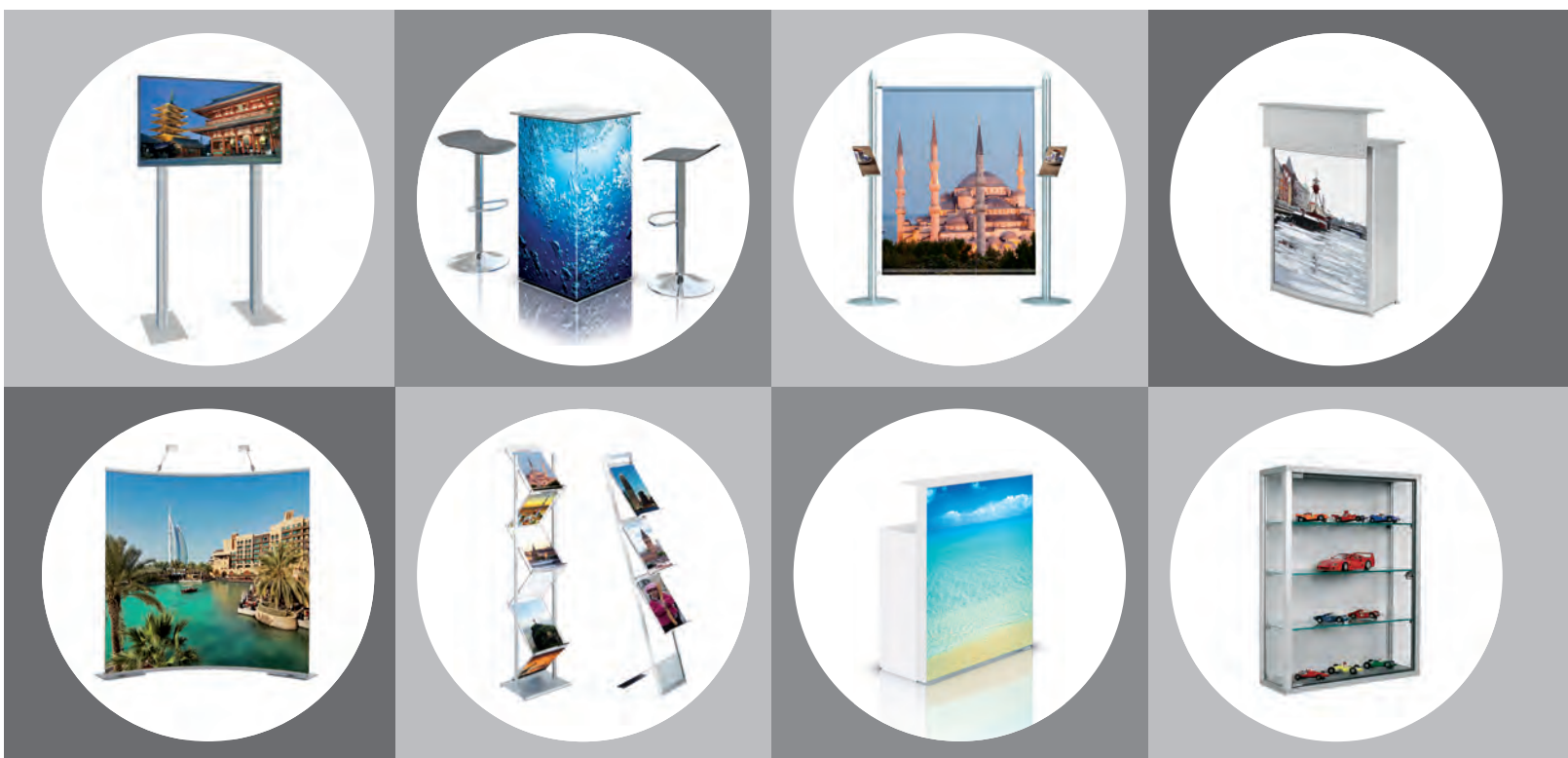

THE ART OF SUCCESSFUL MERCHANDISE

Professional information and communication with OCTANORM Display Systems



AESTHETIC PRESENTATION AS A DESIGN PRINCIPLE

Attract attention at your event, shop or point of sale. OCTANORM's presentation systems are designed to adapt to your changing needs and manufactured from quality materials. Our qualified OCTANORM Partners can recommend the best system based on your objectives.

PORTABLE EXHIBIT SYSTEMS

OCTAWALL MOBIL 4 - 5

OCTALUMINA 6 - 7

OCTAQUICK EXHIBITS 8 - 9

OCTAQUICK ACCESSORIES 10 - 11

POP UP SYSTEMS

VARIO D400 CURVED 12 - 13

BANNER SYSTEMS

VARIO D2 14 - 15

OCTAPOLE 16 - 17

COUNTERS

OCTACOUNTER 18 - 19

OCTALUMINA COUNTER 18 - 19

PRESENTATION RACKS

LITERATURE RACKS 20 - 21

MONITOR STANDS 20 - 21

1

2

3

4

5

OCTAWALL MOBIL - FABRIC SOLUTION

Present easier, better and more efficiently! Create exhibits, free standing walls or partitions with single or double sided fabric graphics with silicone edge. Frames are split for ease of transportation and storage. Incorporate OCTANORM'S magnetic system to showcase your product.



Design example: 9 x W 932, 3 x W 935, 4 x W 992, 4 x M 1498, 1 x Q 800



Corner upright W 992



Magnetic retainer system MF 15, MF 306 S,
MF 150 P, MF 82



LED spotlight M 1498

BASIC MODULES

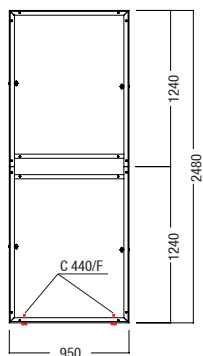

W 932
Frame, split
incl. 2 adjustable feet

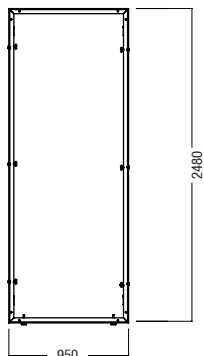

W 934
Frame,
for fixing base plates



W 992
Corner upright, split
incl. 1 adjustable foot

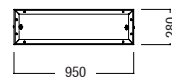

W 935
Frame,
for fascia

This is only a small sample of available OCTAwall mobile articles. The full range of products including our magnet retainer system can be found in our OCTAWALL mobile brochure AW 7945.

ACCESSORIES

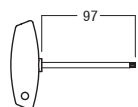

M 951
Hex-star T30

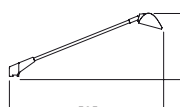

M 1498
LED spotlight
12 W / 230 V / 400 K

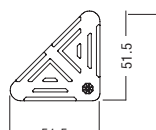

W 1000
Distance piece
for packaging

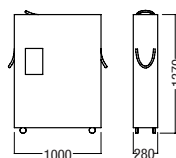

W 925
Transport bag for 3 frames
W 930 or W 932 and 4 corner
extrusions W 992, nylon, blue

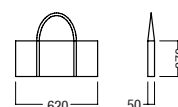

W 927
Transport bag for 2 base plates
M 1951, M 1953 or M 1961,
nylon, blue



MF 80
Steel plate

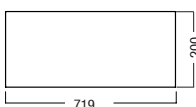

MF 82
Steel plate

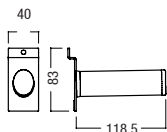

MF 1
Mounting handle

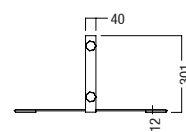

M 1951
Base plate, steel
side, 600 x 250 mm

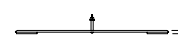

M 1953
Base plate, steel
center, 600 x 250 mm

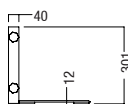

M 1961
Half base plate, steel
side, 320 x 250 mm



M 1963
Half base plate, steel
center, 320 x 250 mm

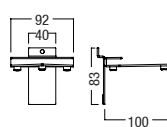

MF 306 S
Bracket, straight
steel, chrome-plated

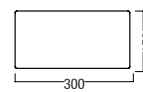

MF 150 P
Wood shelf
white, 8 mm

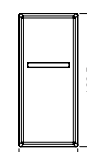

MF 15
Magnetic retainer

TECHNICAL INFORMATION

* DOUBLE FUNCTION OF BEAM Z 308:

1. transport securing device for split frames
2. for holding steel panel MF 80 (or MF 82) of the OCTANORM magnetic fixing system

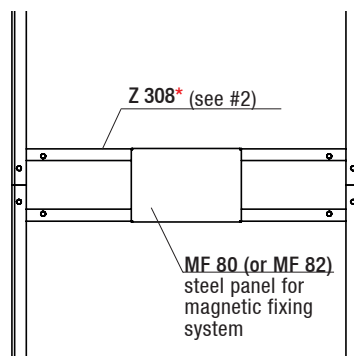
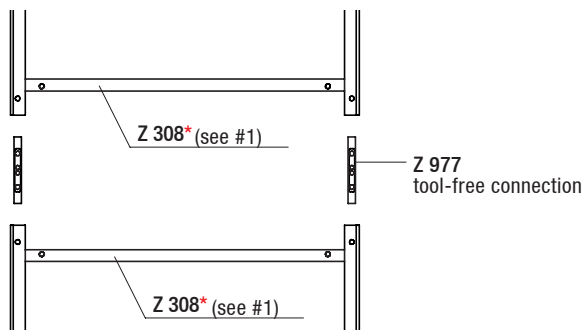

SIZES OF PRINTED PANEL:
Frame: W 950 x H 2480 mm
Frame for fascia: W 950 x H 280 mm

OCTALUMINA - SET HIGHLIGHTS

OCTALUMINA stands for absolutely shadowfree illumination and excellence that will make your company shine. Our high-quality components made from anodized aluminium are dimensionally stable, long-lived, and aesthetically pleasing. Lateral feed-in or backlighting with Power LEDs ensure a homogeneous illumination and long operating times at low power consumption. Free-standing with base plates, wall mounted or suspended from the ceiling; room in room, counter, cabin, or corner solutions; single or double-sided illumination: no problem.



Design example: OL 1230



OCTAlumina Bar Table OL T50



OCTAlumina 120 OL 1202 toolless
incl. transportation bag



OCTAlumina 40 frames OL 415

BASIC MODULES

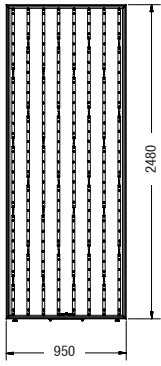

OL 415
Frame 40 mm, single-sided illuminated, incl. 2 adjustable feet, 2 m cable and plug, without graphics

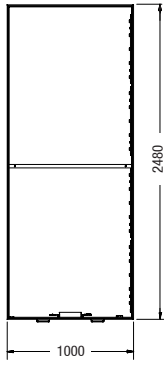

OL 1210
Frame 120 mm, double-sided illuminated, incl. 2 base plates, 2 m cable and plug, without graphics

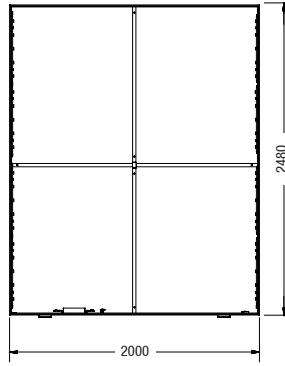

OL 1220
Frame 120 mm, double-sided illuminated, incl. 2 base plates, 2 m cable and plug, without graphics

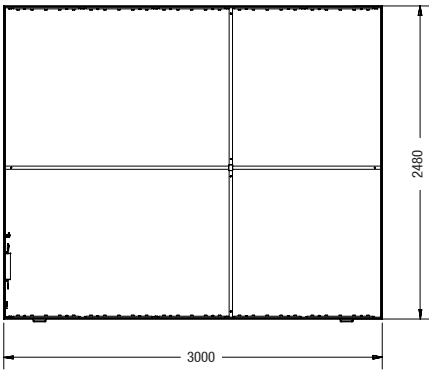

OL 1230
Frame 120 mm, double-sided illuminated, incl. 2 base plates, 2 m cable and plug, without graphics

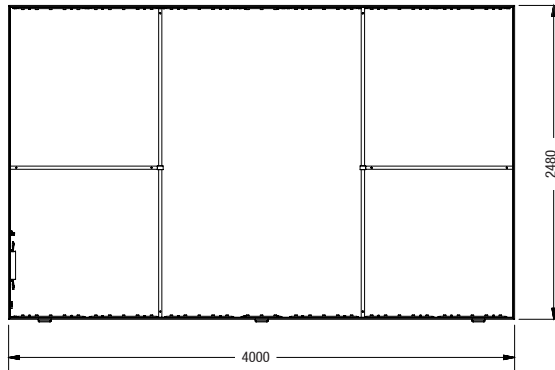

OL 1240
Frame 120 mm, double-sided illuminated, incl. 3 base plates, 2 m cable and plug, without graphics

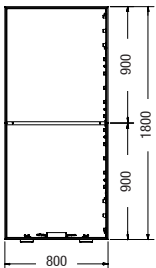

OL 1202
Frame split 120 mm, toolless, double-sided illuminated, incl. 2 base plates, transportation bag, 2 m cable and plug, without graphics

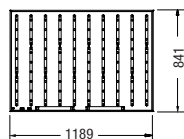

OL 400
Frame 40 mm, single-sided illuminated size: DIN A0 incl. 2 m cable and plug, power supply unit integrated, without graphics

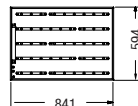

OL 401
Frame 40 mm, single-sided illuminated size: DIN A1 incl. 2 m cable and plug, power supply unit integrated, without graphics

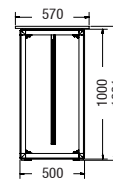

OL T50
Bar table, with 4 illuminated sides, incl. 2 m cable and plug, without graphics

OCTAQUICK EXHIBITS

Participating in exhibitions requires an investment of time and money. OCTAquick has been designed to help you achieve maximum benefits with minimal commitment to the time and cost required to build and dismantle your exhibit. OCTAquick's portable exhibition system can be assembled in minutes by unskilled personnel and can be transported in an estate car or courier. The system comprises four basic modules for the construction of displays that range from a simple panel wall to a medium sized exhibit complete with lights. With OCTAquick's high quality components and stylish design, your do-it-yourself exhibit will have a professional appearance that offers impact and effectiveness.



Suspending the fabric panel



Height-adjustable foot



Easy cable routing

BASIC MODULES

OCTAQUICK 3x3

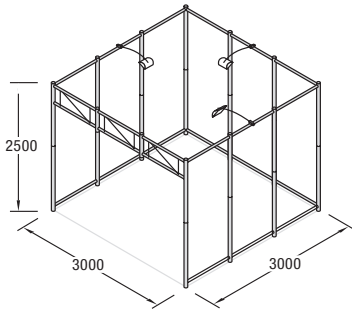

Q 40
Construction set
incl. transport cases Q 501,
Q 502 and lighting 230 V
weight: 176.37 lbs / 80.0 kg

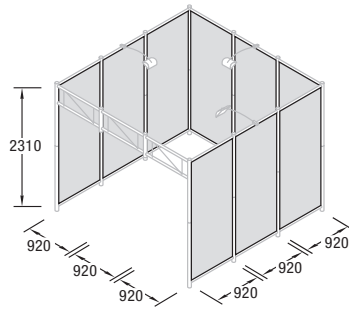

Q 41
Wall infill panel set "fabric", white,
with inserted mounting profile
weight: 23.35 lbs / 11.5 kg

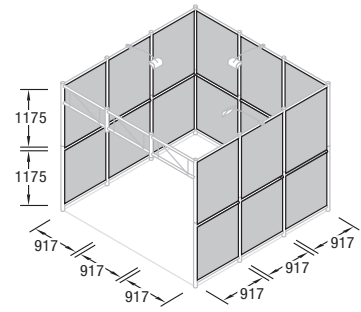

Q 42
Wall infill panel set, white, 3.2 mm,
incl. 9 beams and transport case Q 503
weight: 178.57 lbs / 81.0 kg

OCTAQUICK 3x2

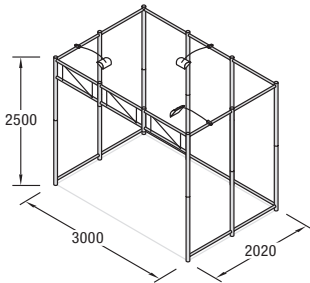

Q 30
Construction set
incl. 2 transport cases Q 502
and lighting 230 V
weight: 147.71 lbs / 67.0 kg

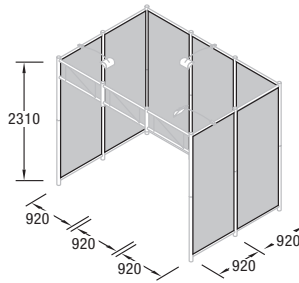

Q 31
Wall infill panel set "fabric", white,
with inserted mounting profile
weight: 19.84 lbs / 9.0 kg

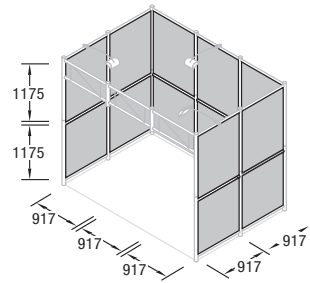

Q 32
Wall infill panel set, white, 3.2 mm,
incl. 7 beams and wooden case
weight: 119.05 lbs / 54.0 kg

OCTAQUICK 3x1

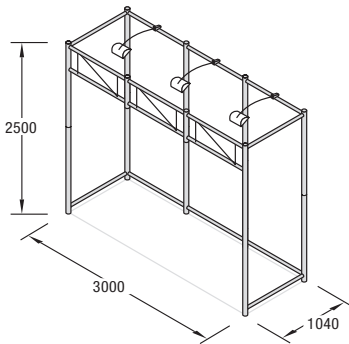

Q 20
Construction set
incl. 2 transport cases Q 502
and lighting 230 V
weight: 120.15 lbs / 54.5 kg

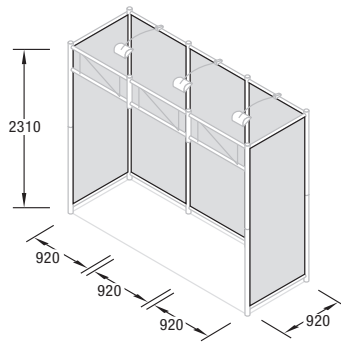

Q 21
Wall infill panel set "fabric", white,
with inserted mounting profile
weight: 11.24 lbs / 5.1 kg

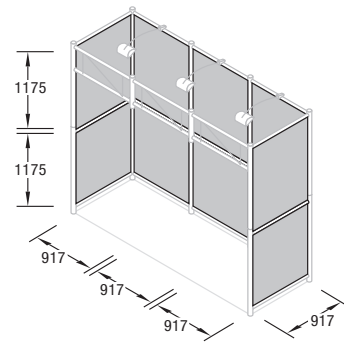

Q 22
Wall infill panel set, white, 3.2 mm,
incl. 5 beams and wooden case
weight: 85.98 lbs / 39.0 kg

WALL

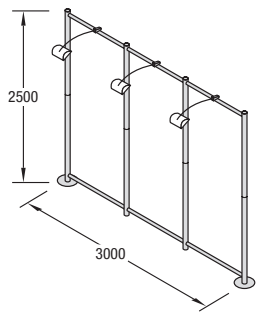

Q 10
Construction set
incl. cardboard box and lighting 230 V
weight: 70.55 lbs / 32.0 kg

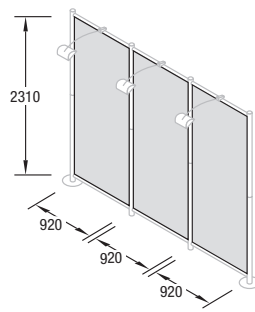

Q 11
Wall infill panel set "fabric", white,
with inserted mounting profile
weight: 8.38 lbs / 3.8 kg

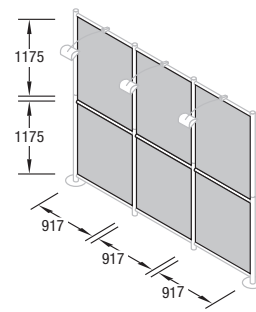

Q 12
Wall infill panel set, white, 3.2 mm,
incl. 3 beams and wooden case
weight: 52.91 lbs / 24.0 kg

For extension modules, accessories and technical information see page 11.

OCTAQUICK ACCESSORIES

Optional accessories help maximize the branding of the company, its products and services. Exhibiting has never been so easy or cost effective.



Sturdy transport cases



Hex-star driver



Shelf set Q 80

ACCESSORIES

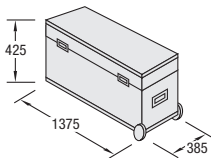

Q 501
Transport case for beams and accessories included in the corresponding sets

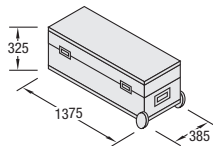

Q 502
Transport case for uprights and accessories included in the corresponding sets

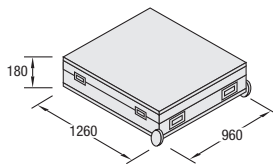

Q 503
Transport case for 3.2 mm wood wall panels and accessories included in wall infill panel set Q 42

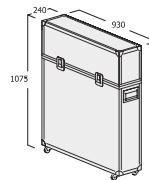

Q 504
Transport box with handle and castors, plastic / aluminium

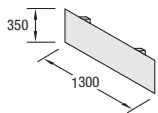

Q 70
Fascia set wood, 10 mm, white

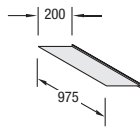

Q 80
Shelf set

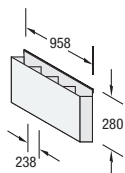

Q 81
Literature holder set

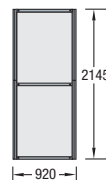

Q 321
Turning door, DIN left aluminium/wood infill, white, 4 mm, lockable, unmounted set



M 1498
Long arm spotlight LED, 12 W / 230 V



Q 99
Assembly tool set incl. in all construction sets

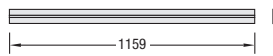

Q 316
Protecting profile for 3.2 mm thick panels incl. in wall infill panel sets "wood"

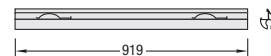

Q 326
Inserted mounting profile for fabric infill panels incl. in wall infill panel sets "fabric"

1

PORTABLE EXHIBIT SYSTEMS

TECHNICAL INFORMATION

Wall infill: fabric

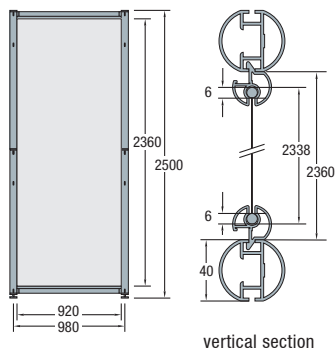

vertical section

Wall infill: panel

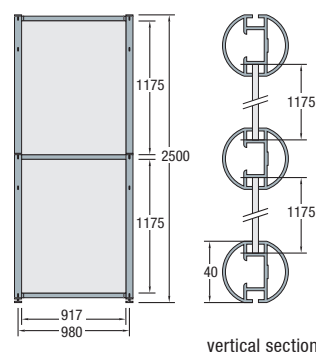

vertical section

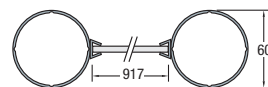

horizontal section

VARIO d400 CURVED

The aluminium side extrusions allow for endless possibilities to customize and expand your display. Create your individual presentation in next to no time by adding literature holders, display shelves and monitors. Vario d400 is a wonderful display for your advertising and P.O.S. presence as well as for merchandise presentation. Transport cases and lighting are included in the sets.



Design example: VA 5833 P1, VA 1240, VA 1213, E 275, E 185 (without monitor)



d400 package in transport case VA 8056



Display shelf VA 1214

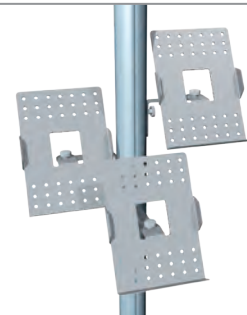

Brochure shelf VA 1240

BASIC MODULES

2

POP UP SYSTEMS

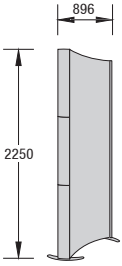

VA 5813 P1
for 1 panel
aluminium side extrusions,
silver anodized, incl. 1 spot

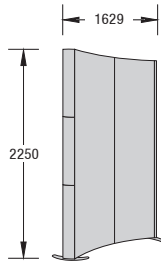

VA 5823 P1
for 2 panels
aluminium side extrusions,
silver anodized, incl. 1 spot

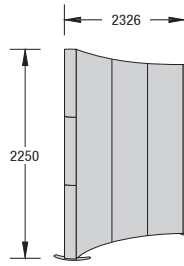

VA 5833 P1
for 3 panels
aluminium side extrusions,
silver anodized, incl. 2 spots

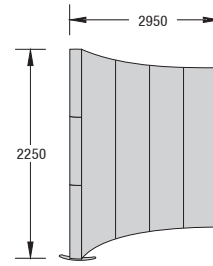

VA 5843 P1
for 4 panels
aluminium side extrusions, silver
anodized, incl. 2 spots

All systems are supplied excluding graphic panels. Package solution includes structure, spotlights and transport case. For other set ups please contact your local OCTANORM display partner.

ACCESSORIES

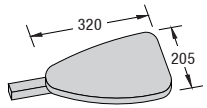

VA 1213
Display shelf
white

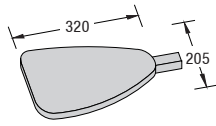

VA 1214
Display shelf
white

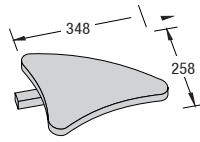

VA 1216
Display shelf
white

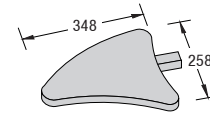

VA 1217
Display shelf
white

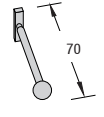

E 275
Bag holder

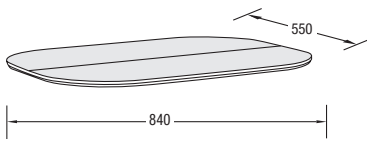

VA 8069
Counter top
for transport case
VA 8056, white,
foldable

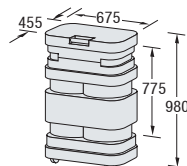

VA 8056
transport
case

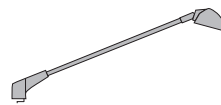

M 1498
Long arm spotlight
LED, 12 W / 230 V

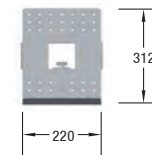

VA 1240
Brochure shelf
universal



VA 5035
Magnetic strip
self-adhesive,
30 m

TECHNICAL INFORMATION

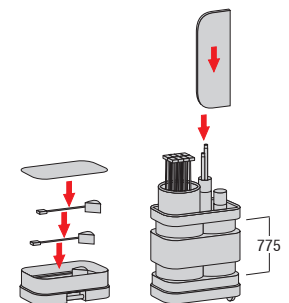
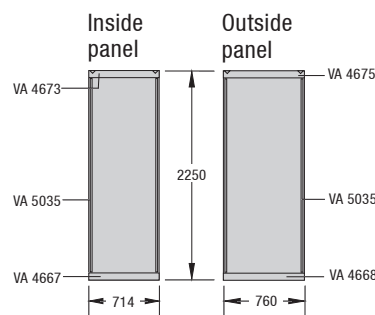
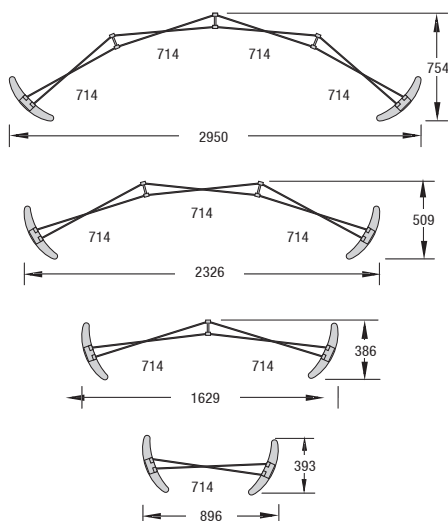

Note: transport case can be used as counter with graphic

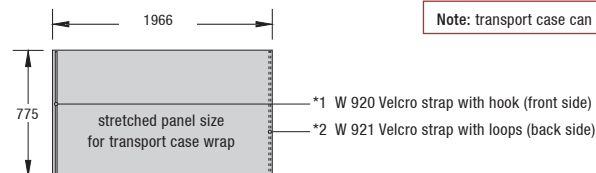

Package solution includes hangers and hooks for inside panels only, for outside panels additional components are needed.

VARIO d2 FABRIC DISPLAY

Attract attention with your message on these units. The beams just slide into the pocket at the top and bottom of your graphic and are attached to the uprights. Tension the fabric and adjust the height by adjusting the beams. Simple, easy and impressive!



Design example: M 1350, Panel recommendation: textile banner with pocket



Tension lock and hex-star driver E 14



Connection of upright and beam

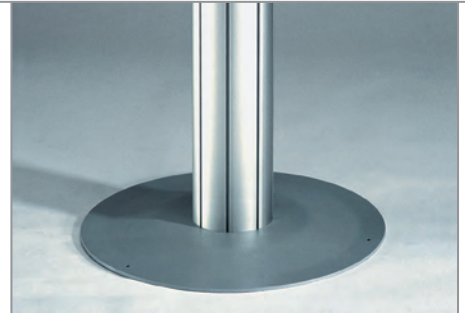

Base plate M 1239 and upright M 1249

BASIC MODULES

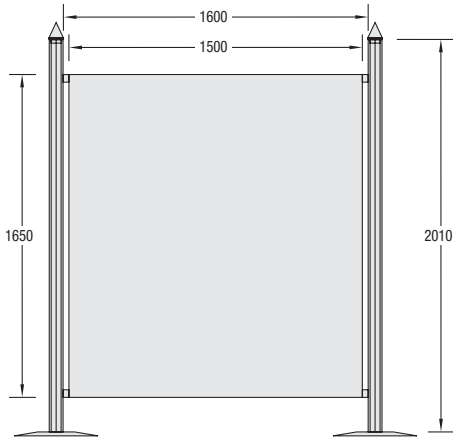

M 1350
Banner set, straight, 2 uprights,
80 mm dia., h=2010 mm, 2 beams
1600 mm long, incl. base plate and cone

Supplied without panels, inside dimensions correspond to banner size. Special versions on request.

3

BANNER DISPLAYS

ACCESSORIES

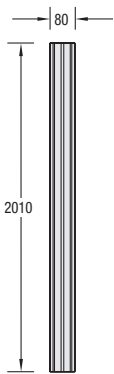

M 1249
Round upright
80 mm, 8 grooves

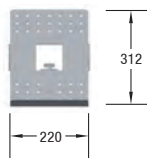

VA 1240
Brochure shelf
universal

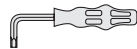

E 14
Hex-star driver

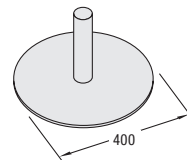

M 1239
Base plate
silver-grey



M 1438
Cone,
wood, silver

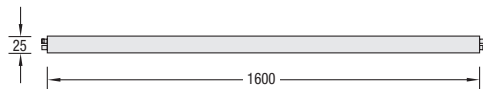

Z 365
Beam with tension locks on both sides, straight

TECHNICAL INFORMATION

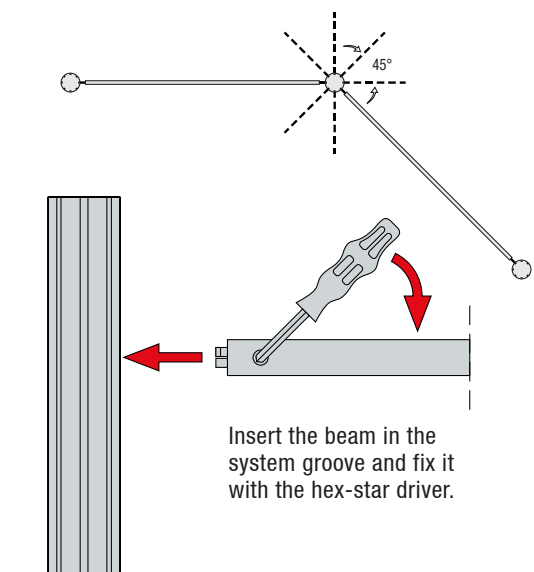
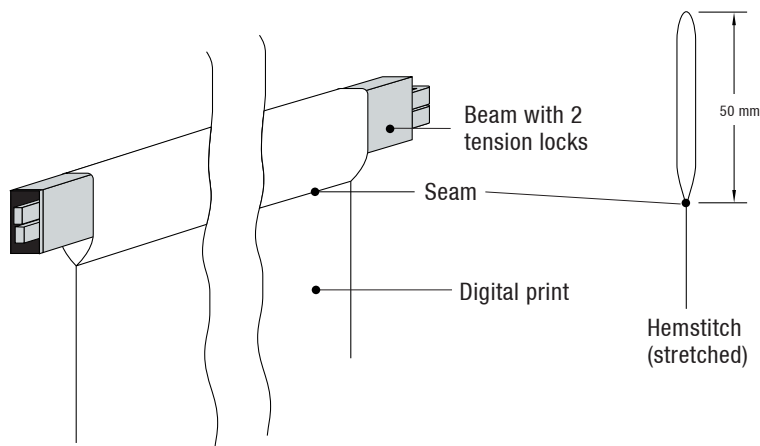

OCTAPOLE BANNER SYSTEM

An easy and effective way to present big impact graphics. This tool free banner system is available in a straight and curved version. The telescopic upright allows easy height adjustment.



Design example: OP 200, 2 x M 1498



Easy to mount without tools



Continuously height adjustable



Telescopic upright

BASIC MODULES

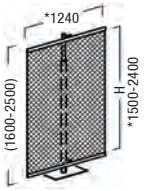

OP 10
Banner set straight
1 telescopic upright and 2 beam extrusions
1240 mm long, incl. 1 base plate

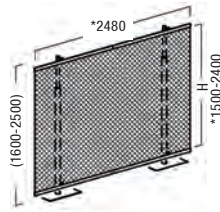

OP 100
Banner set straight
2 telescopic uprights and 4 beam extrusions
1240 mm long, incl. 2 base plates

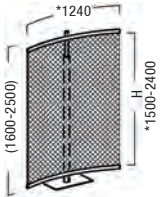

OP 20
Banner set curved concave
1 telescopic upright and 2 beam extrusions
1240 mm long, incl. 1 base plate

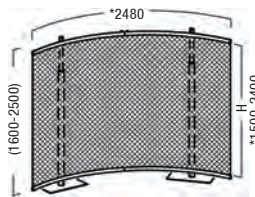

OP 200
Banner set curved concave
2 telescopic uprights and 4 beam extrusions
1240 mm long, incl. 2 base plates

* fabric dimensions

Supplied without graphic panels. Special dimensions on request.

ACCESSORIES

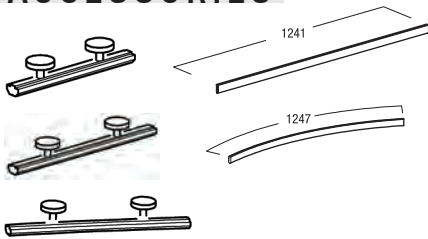

Beam (M 1356)
OP 181 beam straight
OP 183 beam curved concave

Beam connector
OP 180 connector straight, 60 mm
OP 172 connector straight, 120 mm
OP 174 connector curved, 120 mm
OP 176 connector curved concave, 120 mm



OP 150
Telescopic upright
adjustable, 40/60 mm,
aluminium



M 1356
Aluminium 5000 mm



OP 158/N
Adaptor top
with fixing screw
70 mm



OP 160/N
Adaptor bottom
with fixing screw
60 mm



OP 155
Base plate, steel,
silver powder-coated



M 1498
Long arm spotlight LED
12 W / 230 V

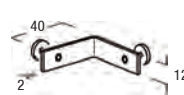

OP 165
Angle connector 90°
zinc-plated, with
2 knurled-screws

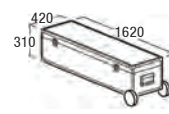

OP 191
Transport case
for all sets

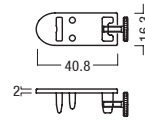

M 1365/KS
End cap
plastic
for M 1356

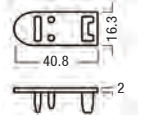

M 1365/K
End cap
plastic
for M 1356

TECHNICAL INFORMATION

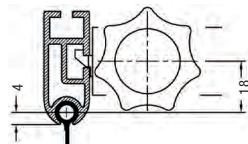

Round welt min. 4 mm dia.
and max. 6 mm dia.
(extrusion opening 8 mm dia.)

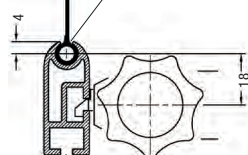

M 1356

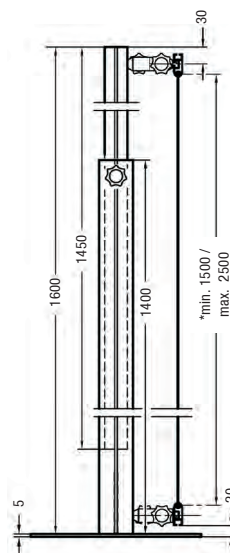

OCTACOUNTER AND OCTALUMINA COUNTER

The sturdy, robust OCTAcounter is assembled easily and without tools. Graphics and a privacy screen are easily added and the optional doors are lockable. Units can be connected for larger reception counters. The OCTAcounter fabric simply unfolds. Drop in the shelves and counter top, and you are ready for your presentation. The OCTALUMINA Counter captivates with its illuminated front: the OCTALUMINA 80 frame is the perfect eye-catcher. The LED modules and power supply unit are pre-assembled and the side panels fold in. Simple, easy and powerful!



Design example: Q 400.31 and OL C500



Q 400.31 with counter top extension
Q 420.31

BASIC MODULES + ACCESSORIES Q 400

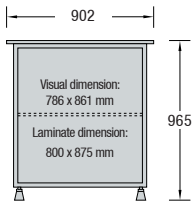

Q 400.31
Basic set,
silver-grey
RAL 9006

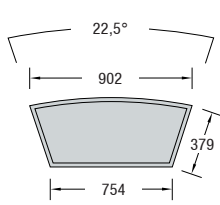

Q 400.30
Basic set,
white

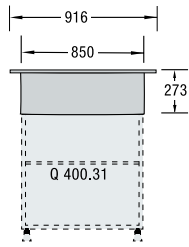

Q 420.31
Counter top extension
perforated wood / aluminium panel

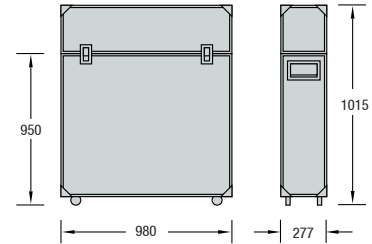
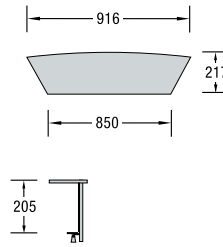

Q 510
Transport case
for 1 basic module Q 400

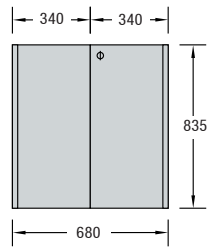

Q 411.31
Door set
silver-grey
RAL 9006

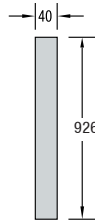

Q 411.30
Door set
white

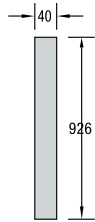

Q 412.31
Connection set
silver-grey
RAL 9006

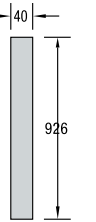

Q 412.30
Connection set
white

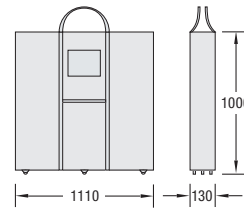

Q 511/N
Transport bag with castors
for 1 basic module Q 400 and
1 door set Q 411, grey

TECHNICAL INFORMATION

ADDITIONAL INFORMATION Q 400:

Extrusions:	aluminium, E6/EV 1 silver anodized
Counter top:	wood, 16 mm
Side panels:	wood, 16 mm
Drawer panels:	wood, 16 mm (below and center)
Front panel:	wood, 3.2 mm
Feet:	adjustable (approx. 10 mm)
Door set:	2 wooden double door, tool-free assembly, lockable, 2 keys

Special finishes upon request.

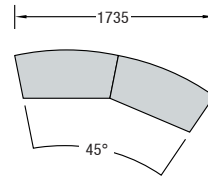

2 basic sets
1 connection set

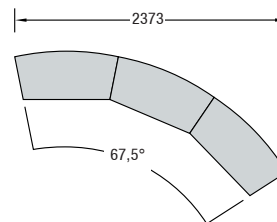

3 basic sets
2 connection sets

BASIC MODULES + ACCESSORIES OL C 500

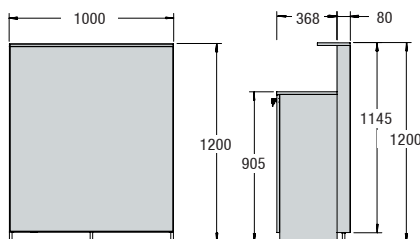

OCTALUMINA OL C500
OCTALUMINA Counter
basic set incl. door set

OCTALUMINA OL C505
OCTALUMINA Counter
basic set without door set

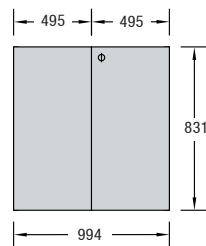

OL C580
Door set
OCTALUMINA
Counter

ADDITIONAL INFORMATION OL C500:
Measurements for prints OL C500: 1000 mm x 1129 mm

LITERATURE RACKS

Quality, durable literature racks allow you to present your brochures in style. Freestanding and wall mounted versions are ideal for showcasing your literature at events, lobbies or shops.



MONITOR PRESENTATIONS

Present your digital media with our solutions for monitors from 36 - 52". Accessories for literature and graphics complete the range for added value.



Design example: P-ZZ6, P-3, P-1 and P-2, VA 5524 with screen

MOBILE LITERATURE RACKS

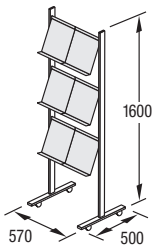

P-6
6 acrylic shelves
with castors

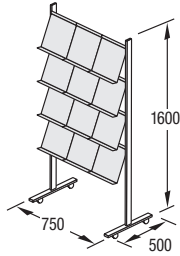

P-12
12 acrylic shelves
with castors

LITERATURE RACKS

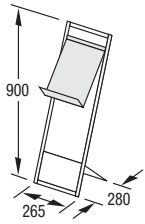

P-1
1 acrylic shelf

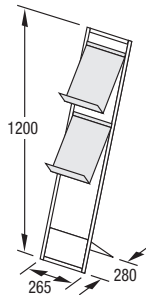

P-2
2 acrylic shelves

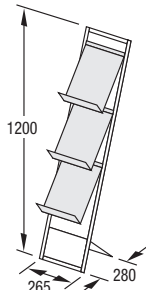

P-3
3 acrylic shelves

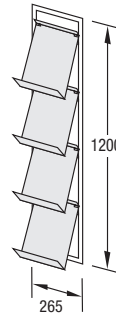

P-4W
4 acrylic shelves
for wall mounting

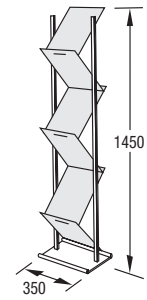

P-ZZ6
6 acrylic shelves

MONITOR ADAPTOR

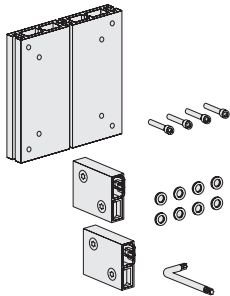

E 185
Monitor adaptor

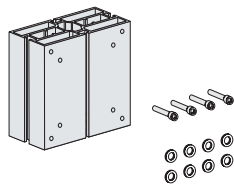

E 184
Monitor adaptor for
OCTAwall mobil 40 fabric

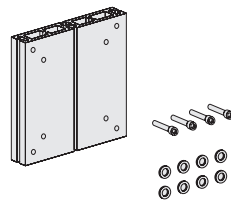

E 186
Monitor adaptor

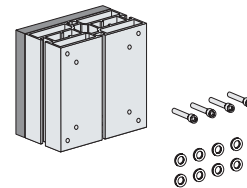

E 187
Monitor adaptor
for OCTAwall 60 fabric

MONITOR STANDS

36" - 52"

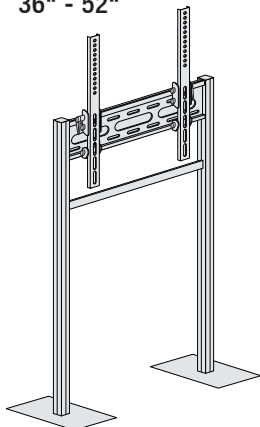

VA 5524
Monitor stand set, without transport case

TECHNICAL INFORMATION

Dimensions and angles of VA 5524

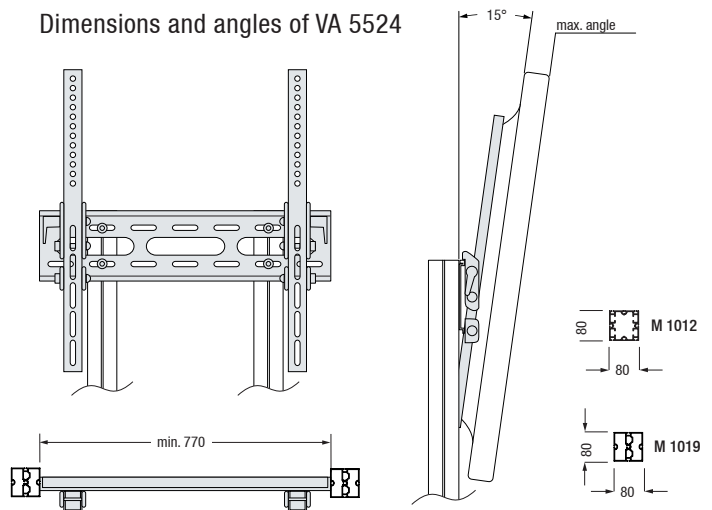

exhibition systems
interior design systems
presentation systems
cleanroom systems
software and service

WAY BEYOND THE NORM: DISPLAY AND PRESENTATION SYSTEMS FROM OCTANORM.

We are here if you have any questions. Would you like a quotation? More information? An appointment? We look forward to your call, your query and you! Welcome to OCTANORM!

AW 6600.GB-11/2018

THE
WORLD
OF
SYSTEMS

www.octanorm.com

OCTANORM 